

Quick Start Guide

SpeedFace M4

Version: 1.0

Overview

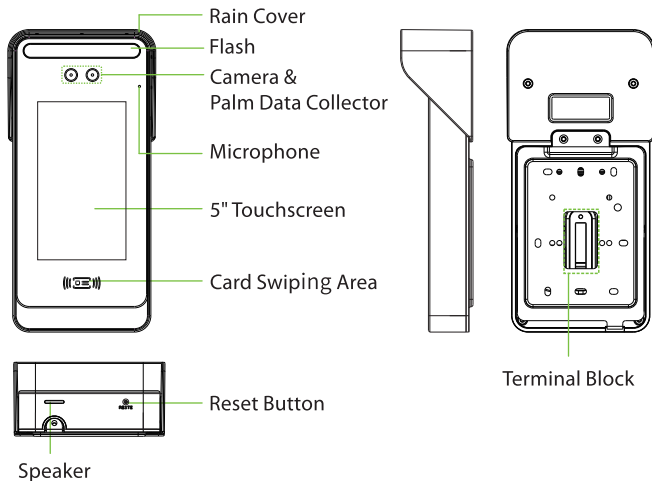

Terminal Block

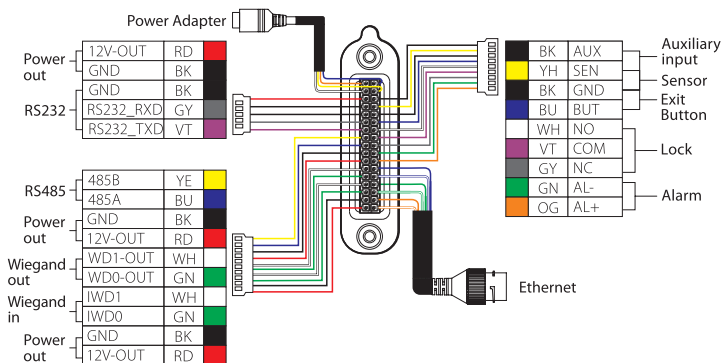

Standalone Installation

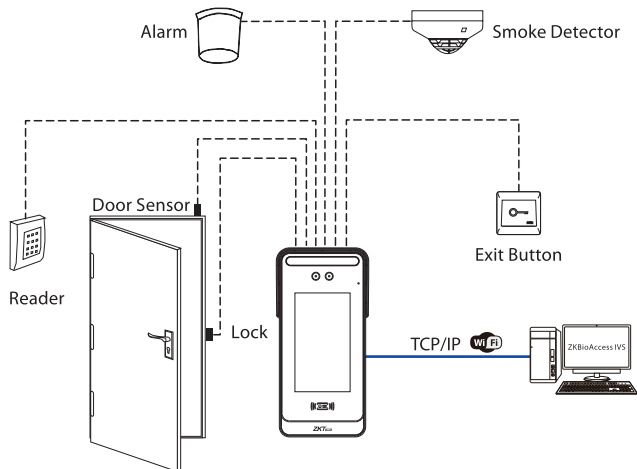

Device Installation

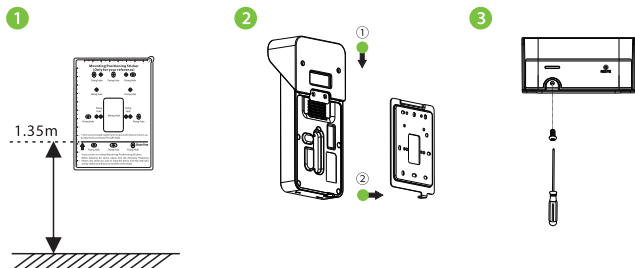

- ① Attach the mounting template sticker to the wall, and drill holes according to the mounting paper. Fix the back plate on the wall using wall mounting screws.
- ② Attach the device to the back plate.
- ③ Fasten the device to the back plate with a security screw.

Ethernet Connection

Connect the device and the system software over an Ethernet cable. An example is shown below:

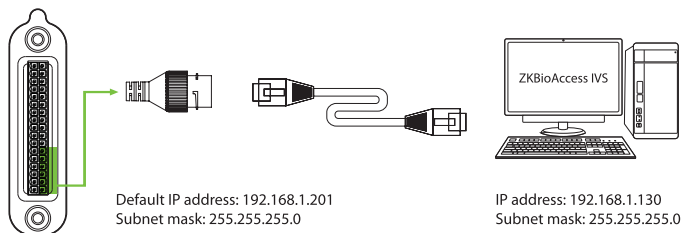

Click [COMM.] > [Ethernet] > [IP Address], input the IP address and click [OK].

Note: In LAN, IP addresses of the server (PC) and the device must be in the same network segment when connecting to ZKBioAccess IVS software.

Door Sensor, Exit Button, Power & Alarm Connection

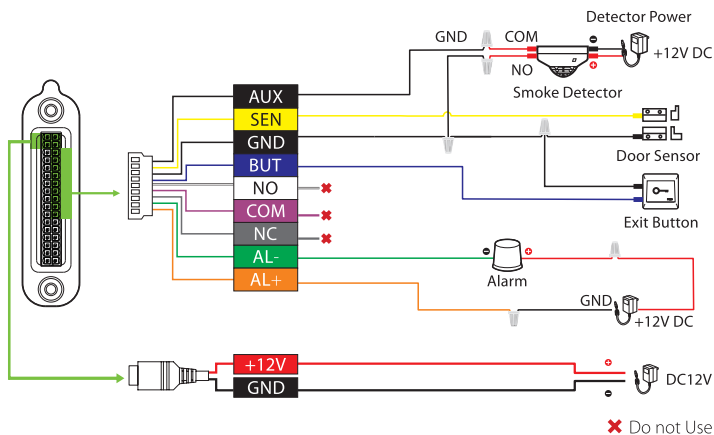

- Recommended AC adapter: 12V, 3A
- To share the power with other devices, use an AC adapter with higher current ratings.

Lock Relay Connection

The system supports both **Normally Opened Lock** and **Normally Closed Lock**. The **NO Lock** (normally opened when powered) is connected with 'NO1' and 'COM' terminals, and the **NC Lock** (normally closed when powered) is connected with 'NC1' and 'COM' terminals. The power can be shared with the lock or can be used separately for the lock, as shown in the example with NC Lock below:

1. Device not sharing power with the lock

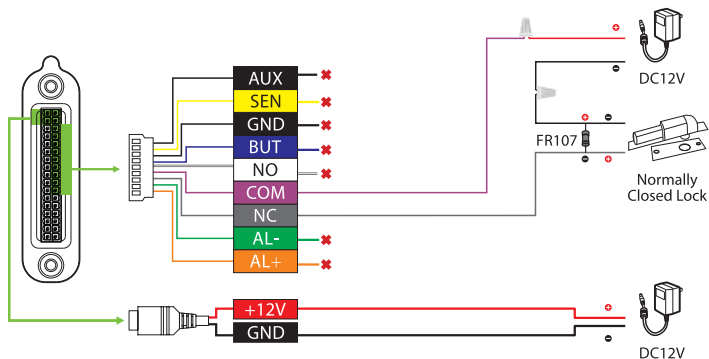

2. Device sharing power with the lock

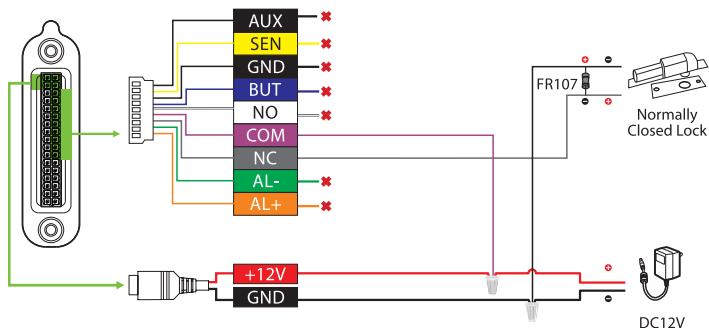

Wiegand Reader & Access Controller Connection

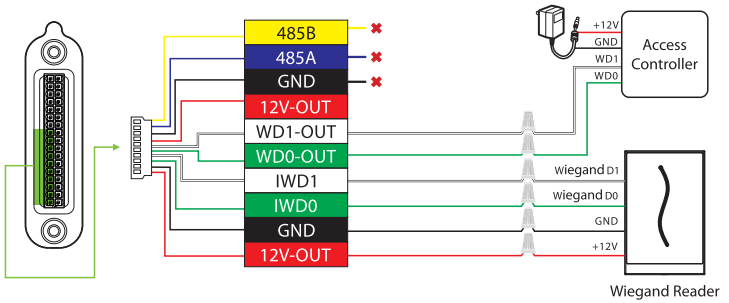

RS485 Connection

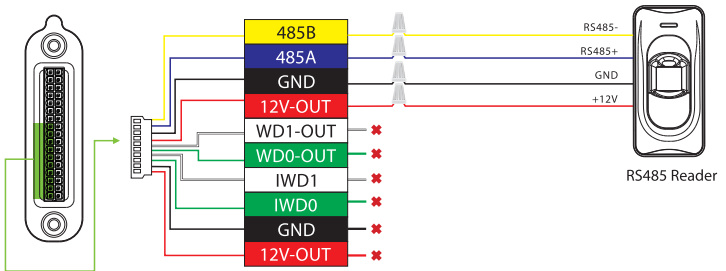

User Registration

When there is no super administrator set in the device, click on  to enter the menu. Add a new user and set User Role to Super Admin, then the system will request for the administrator's verification before entering the menu. It is recommended to register a super administrator initially for security purposes.

Method 1: Registering on the device

Click on  > [User Mgt.] > [New User] to register a new user. The options include entering the user ID and Name, setting User Role, registering a Palm, Face, Card Number, Password and adding Profile Photo.

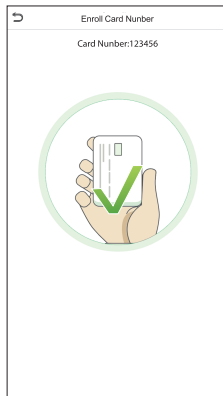
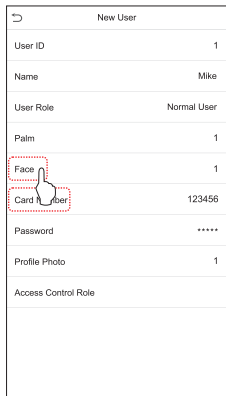
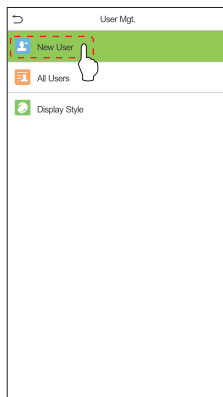
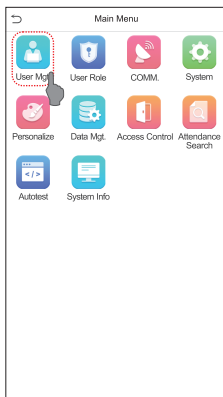
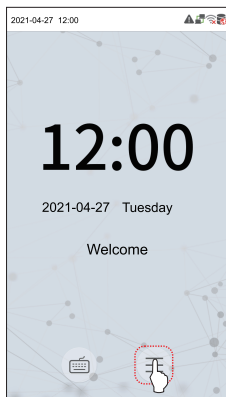

Method 2: Register on ZKBioAccess IVS software

Please set the IP address and cloud service server address in the Comm. Menu option on the device.

1. Click **[Access]** > **[Access Device]** > **[Device]** > **[Search Device]** to search the device on the software. When an appropriate server address and port is set on the device, the searched devices are displayed automatically.

The screenshot displays the 'Search Device' window in the ZKBioAccess IVS software. The interface includes a search bar, a progress bar, and a table of found devices. A dialog box titled 'Add' is open, showing fields for Device Name, Icon Type, Area, and Add to Level. A warning message is displayed at the bottom of the dialog.

IP Address	MAC Address	Subnet Mask	Gateway Address	Serial Number	Device Type	Set Server	Operation
192.168.213.79		255.255.255.0	192.168.213.1		Personnel		Add

Step 1: Clicking the Search button.

Step 2: The search progress bar reaching 100%.

Step 3: Clicking the Add button in the Operation column.

Step 4: Clicking the OK button in the 'Add' dialog box.

2. Click **[Add]** in operation column, a new window will pop-up. Select Icon type, Area, and Add to Level from each dropdowns and click **[OK]** to add the device.
3. Click **[Personnel]** > **[Person]** > **[New]** and fill in all the required fields to register a new users in the software.
4. Click **[Access]** > **[Device]** > **[Device Control]** > **[Synchronize All Data to Devices]** to synchronize all the data to the device including the new users.

For more details, please refer to the ZKBioAccess IVS User Manual.

Method 3: Register on the phone

Once the ZKBioAccess IVS software is installed, the users could enroll their face via a browser application on their own mobile phone.

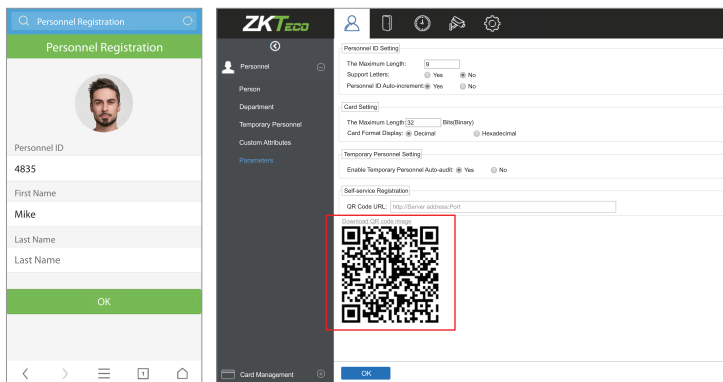

1. Click **[Personnel]** > **[Parameters]**, input "http://Server address: Port" in the QR Code UGL bar. The software will automatically generate a QR code. Scan the QR code or login onto "http://Server address: Port/app/v1/adreg" by the mobile phone to register users.



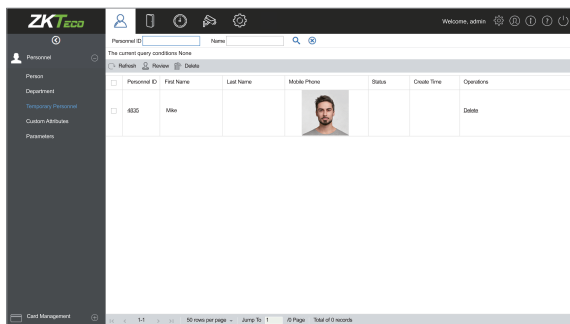

2. The users will be displayed in **[Personnel]** > **[Temporary Personnel]**, click on **[Review]** option and assign a department and click **[OK]** to successfully add the user.



Ethernet and Cloud Server Settings

Click on  > [COMM.] > [Ethernet] to set the network parameters. If the TCP/IP communication of the device is successful, the icon  will be displayed in the upper right corner of the standby interface.

Click on  > [COMM.] > [Cloud Server Setting] to set the server address and server port, that is, the IP address and port number of the server after the software is installed. If the device communicates with the server successfully, the icon  will be displayed in the upper right corner of the standby interface.

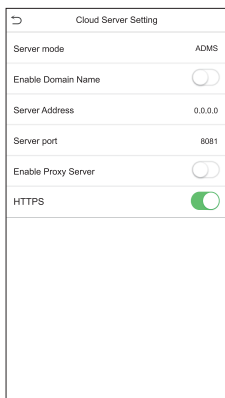
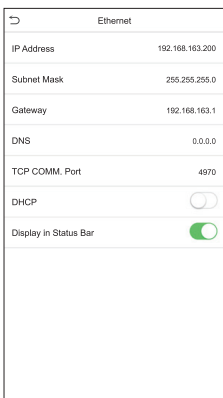
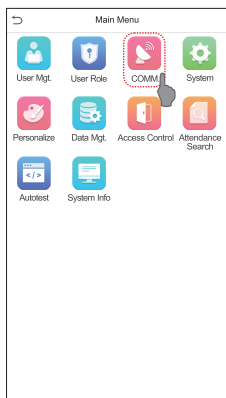

Access Control Settings

Click on  > [Access Control] to enter the access control management interface and set relevant parameters of access control.

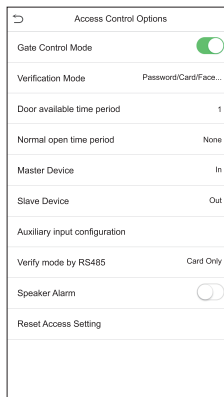
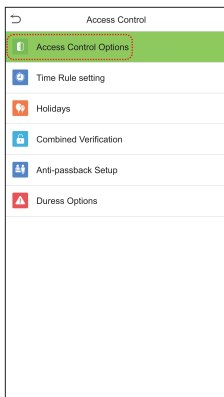
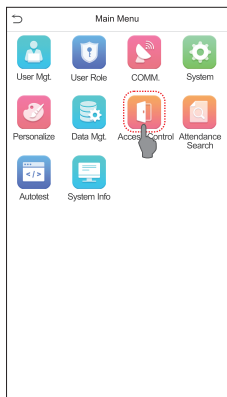

Records Query

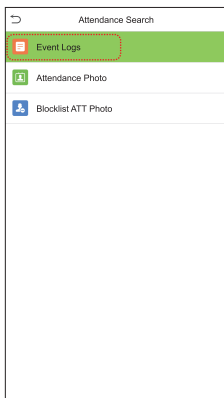
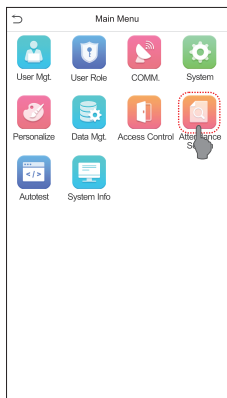

Personal Record Search

Date	User ID	Time
03-03	Number of Records:04	
	4	11:25
	2	11:25 11:22
03-04	Number of Records:04	
	3	11:25
	1	11:29
	3	11:29 11:21
03-05	Number of Records:04	
	2	11:28
	4	11:26
	1	11:27
	4	11:27
	3	11:27
	2	11:27

Click on  > [Attendance Search] > [Event Logs] to enter the records query interface, input the user ID and select the time range, the corresponding event logs will be displayed.

Detection Management Settings

Click on  > [System] > [Detection Management] to enter the setting interface.

- 1 You can **Enable mask detection** function, and enable the **Deny access without mask** and the **Trigger external alarm**, the device will send an alarm prompt when the user doesn't wear a mask, meanwhile the user will be forbidden to access, as shown in the following figure.
- 2 When the **Allow unregistered people to access** is enabled, you can also set **Enable capture of unregistered person** to save the user photo.

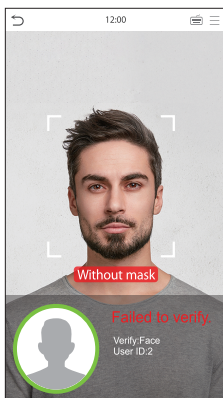
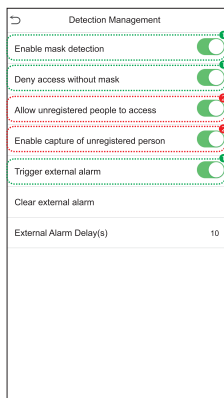
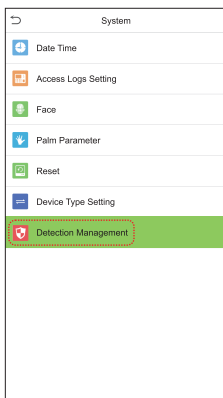
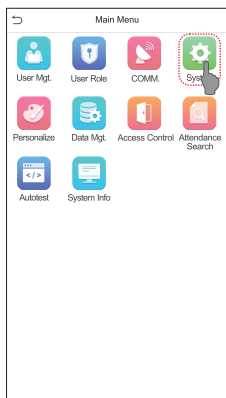

Recommended Palm Gestures

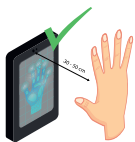

KEEP EFFECTIVE
DISTANCE OF
30-50 cm



KEEP SPACES
BETWEEN
YOUR FINGERS



DO NOT KEEP
YOUR FINGERS
CLOSE



DO NOT KEEP
PALM OUTSIDE
COLLECTION AREA



DO NOT KEEP
YOUR FINGERS
FOLD/CURLED

Note:

1. Place your palm within **30-50 cm** of the device.
2. Place your palm in the palm collection area, such that the palm is placed parallel to the device.
3. Make sure to keep space between your fingers.
4. Please avoid direct sunlight when using the palm function outdoors. According to laboratory test, the palm recognition effect is best when the light intensity is not more than 10,000 lux.

ZKTeco Industrial Park, No. 32, Industrial Road,
Tangxia Town, Dongguan, China.

Phone : +86 769 - 82109991

Fax : +86 755 - 89602394

www.zkteco.com

